



**CRUISING DESIGN
INTERNATIONAL**



Flexible Furler 7/9

Installation and Operating Manual

1036 Waverley St., Winnipeg, MB R3T 0P3

Toll Free: (844) 379-2407

Fax: (204) 896-6969

info@sailcdi.com



WARNINGS – READ BEFORE INSTALLING OR USING YOUR FURLER

Improper installation of the Flexible Furler or improper reinstallation of the forestay can cause failure of the forestay, and could result in the loss of the mast and injury to crew members.

PRE-INSTALLATION WARNING:

You must use toggles at both ends of the forestay. Improper toggling may cause the forestay to fatigue due to bending stresses.

POST INSTALLATION WARNINGS & SAFETY CHECKLIST:

1. All clevis pins and cotter pins (especially tumbuckle cotter pins) removed during installation must be replaced.
2. Turnbuckle threads must have full engagement.
3. Make sure your furler rotates freely.
4. The luff and the inside of the drum must not touch the tumbuckle body. If they touch, furling may unscrew the tumbuckle.
5. The luff support pin must be installed, or the turnbuckle will unscrew and cause dismasting.
6. Insure that the bearing is not jammed, as winching with a jammed bearing will transmit torsional loads to the tumbuckle which could lead to failure.
7. There must be at least 3" clearance on the sides and above the halyard top fitting.

OPERATION WARNINGS & SAFETY CHECKLIST:

1. Never winch the unit without checking for jams or snarls. Winching against an obstruction can sever or cause hidden damage to your forestay.
2. Keep your unused halyards flipped to the after side of your spreaders and lightly tensioned.
3. If the unit becomes hard to furl, investigate and correct the cause. Failure to do so can lead to the failure of the forestay.

(Continued next page)

USAGE WARNINGS:

The Flexible Furler is designed to reef and furl forward sails, i.e. jibs and staysails. The Flexible Furler is not intended for use as a mainsail or mizzen furler.

The Flexible Furler is NOT designed to be used while your boat is in the water and passing under low clearance obstructions (bridges, power lines, etc.) with mast tipped forward and headstay attached to the bow. Lowering the mast in this manner is dangerous even without a furler, and can be further complicated by the weight of the furler and the sail.

“This product is intended for use only on sailboats having masts fixed vertically in place at all times while the boat is in the water, wherein the mast may only be lowered in accordance with the boat manufacturer’s instructions when the boat is on land. **Any other use of the product constitutes misuse, and may result in damage to the product, and/or serious injury to the user.**”

NOTICES RELATING TO THE MISUSE OF CDI FURLERS

INDEMNIFICATION. *UPON PURCHASING THIS PRODUCT, THE PURCHASER AGREES TO HOLD HARMLESS AND INDEMNIFY CDI AGAINST ANY LAWSUIT, CHOSE IN ACTION, OR CAUSE OF ACTION ARISING OUT OF THE USE OF THIS PRODUCT OTHERWISE THAN ON SAILBOATS HAVING MASTS FIXED IN PLACE AT ALL TIMES WHILE THE BOAT IS IN THE WATER, WHEREIN THE MAST MAY ONLY BE LOWERED IN ACCORDANCE WITH THE BOAT MANUFACTURER’S INSTRUCTIONS WHEN THE BOAT IS ON LAND.*

INDEX

Warnings.....	Inside Front Cover – Page 1
Notice of Misuse / Indemnification.....	1
Specifications.....	2 - 3
Parts Drawing.....	4
Parts List.....	5
Uncoiling and Straightening the Luff.....	6 - 7
Assembly.....	8 - 13
Installing the Furling Line.....	13 - 14
Hoisting the Jib.....	14 - 15
Lowering the Jib.....	15
Sailing with your Furler.....	16 - 17
Land Transporting your Furler	17
Maintenance & Storage.....	17 - 19
Sailmaker's / Rigger's Instructions.....	19 - 20
Warranty.....	Back Cover

SPECIFICATIONS

	<u>FF7.0</u>	<u>FF9.0</u>
Headstay Length	Up to 47'	Up to 53'
Wire Size	7/32", 1/4"	1/4", 9/32", 5/16"
Turnbuckle Size	3/8", 7/16", 1/2"	1/2", most 5/8"

Headstay Fittings There must be a toggle at both ends of the headstay. The turnbuckle must be a swage on turnbuckle with a T-bolt and toggle on the bottom (see page 5), and it *MUST be locked by cotter pins*. You may NOT use 3-piece (Navtec) turnbuckles. The stud must NOT have non-marine protuberances (such as aircraft hex nuts). If your turnbuckle doesn't meet *all* of the above requirements, replace it with one that does.

Mounting The system can NOT be mounted above the turnbuckle. If you wish to raise the system for better clearance, shorten the stay and use link plates below the turnbuckle.

Furling Line 1/4" braid on braid dacron. If you prefer a larger diameter, you should de-core the

portion of line forward in the cockpit. (Otherwise the larger line won't fit onto the furling drum.)

Usage

The Flexible Furler is designed to reef and furl forward sails, i.e. jibs and staysails. The Flexible Furler is not intended for use as a mainsail or mizzen furler.

The Flexible Furler is intended for use on sailboats having **fixed masts in place, standing upright, at all times while the boat is in the water**, wherein the mast may only be lowered in accordance with the boat manufacturer's instructions when the boat is on land. Any other use of the product constitutes misuse, and may result in damage to the product, and/or serious injury to the user.

The Flexible Furler is NOT designed to be used while your boat is in the water and passing under low clearance obstructions (bridges, power lines, etc.) with mast tipped forward and headstay attached to the bow. Lowering the mast in this manner is dangerous even without a furler, and can be further complicated by the weight of the furler and the sail.

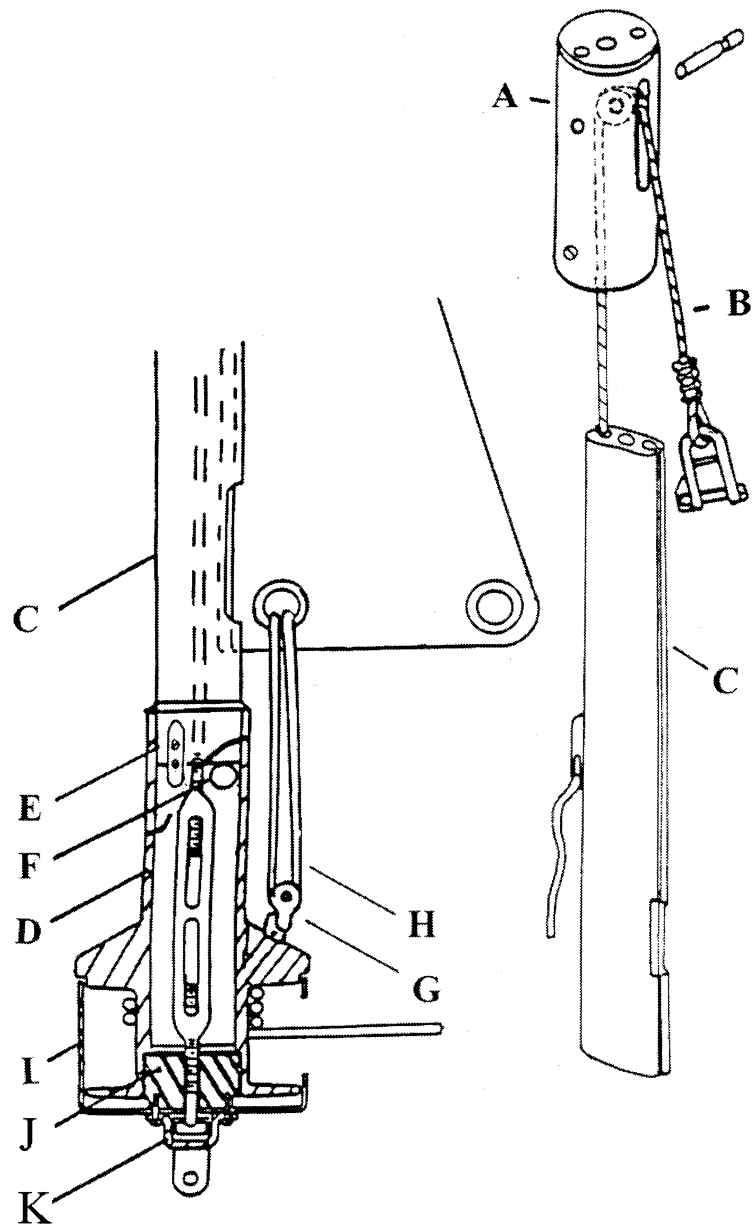

(4)

FF7.0 PARTS LIST

<u>Ref</u>	<u>Description</u>	<u>Part #</u>
A	Halyard Top Fitting Assembly.....	2056
	Sheave.....	1157
	Pin.....	1046
B	Halyard Assy, 5/32" wire x 49' w/ traveler, shackle and micropress eye.....	1001
C	Luff Extrusion.....	LFF7
D	Spool Assembly.....	1917
E	Cleat.....	9000
F	Luff Support Pin.....	1865
G	Anchor Pin.....	1936
	Anchor Shackle.....	1935
	Tack Downhaul Block.....	2066
H	Tack Downhaul Line, 5/32" x 12'.....	--
I	Cup, stainless steel.....	1805
J	Ball Bearing.....	BB7
K	Antirotation Strap.....	1074
	Instruction Manual (not shown).....	--

FF9.0 PARTS LIST

<u>Ref</u>	<u>Description</u>	<u>Part #</u>
A	Halyard Top Fitting Assembly.....	2059
	Sheave.....	2069
	Pin.....	2067
B	Halyard Assy, 5/32" wire x 53' w/ traveler, shackle and micropress eye.....	2063
C	Luff Extrusion.....	LFF9
D	Spool Assembly.....	2064
E	Cleat.....	9000
F	Luff Support Pin.....	1865
G	Anchor Pin.....	1936
	Anchor Shackle.....	1935
	Tack Downhaul Block.....	2066
H	Tack Downhaul Line, 5/32" x 12'.....	--
I	Cup, stainless steel.....	1805
J	Ball Bearing.....	BB9
K	Antirotation Strap.....	2068
	Instruction Manual (not shown).....	--

UNCOILING THE LUFF EXTRUSION – READ WARNINGS AND UNCOILING INSTRUCTIONS BEFORE UNCOILING!

WARNINGS:

- *Be careful!* Coiled luffs have a lot of stored energy. Careless cutting of the tape bands that restrain the luff can cause sudden and uncontrolled uncoiling resulting in injury especially to the face and eyes.
- *Wear face and eye protection.*
- *Read instructions completely before cutting the tape.*
- *Never cut all tape bands at once!*
- **Uncoil the luff extrusion within a day of receipt.** If uncoiled promptly, the luff extrusion will gradually come straight. If left coiled for more than a week, the luff extrusion will take a set and will require a straightening process (see page 7).

UNCOILING INSTRUCTIONS

1. Lay the luff extrusion on the ground.

2. Stand on the inside of the luff to avoid having the luff spring at you and strike you when the tape band is cut.

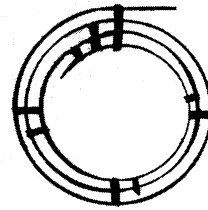

Figure 1

3. Start at the band of tape which is closest to the straight tail of the luff extrusion, as shown in Figure 1. Cutting this band will allow the outermost wrap to uncoil 90 degrees as shown in Figure 2. Carefully cut the first band of tape.

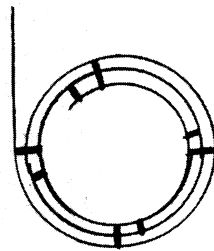

Figure 2

4. Carefully cut the next band of tape holding the outermost wrap as shown in Figure 3. This will allow the luff to uncoil another 90 degrees.

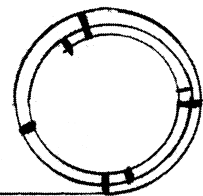

Figure 3

(6)

5. Continue to carefully cut the outermost bands of tape so that the luff extrusion is uncoiled 90 degrees at a time. STOP before cutting the last band of tape.
6. Make sure everyone is clear of the luff so that when the final band of tape is cut, no one can be hurt. Keep the luff lying on the ground. While standing inside the final coil, cautiously cut the final band of tape.

STRAIGHTENING INSTRUCTIONS

(Straightening is not necessary if you uncoil your luff within a day of receipt. If your luff is already straight, skip ahead to page 8, "Assembly.")

It is easier to straighten the luff coil in warm weather (72 degrees F or higher). If it's cold outside, first allow the coil to warm up inside. Then take it out to uncoil (see below). Bring it back inside to accelerate straightening.

Find at least two additional people (preferably more) and recoil the curved portion in one large loop in the opposite direction. Keep the luff level to prevent twisting. Note that the lower end, from the sail feed slot to the bottom, was shipped straight and should not be recoiled (see drawings below).

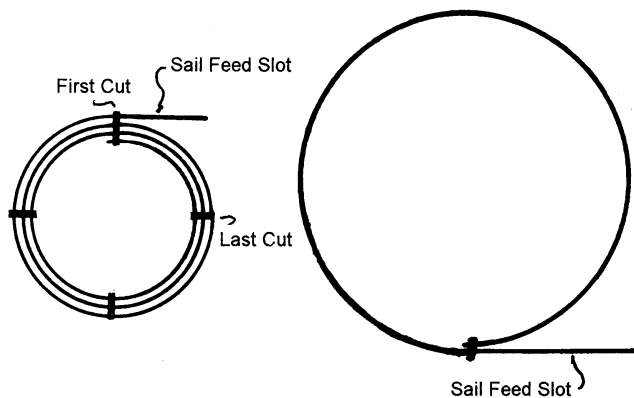

After coiling in the opposite direction, tape the upper end to the lower portion above the sail feed slot, leaving the straight portion free. Let the coil stand for several hours: a minimum of three if it's warm, longer, perhaps overnight, if it's cold. After this time, carefully cut the tape and check the straightness. The luff does not need to be perfectly straight as a tight forestay will finish the job.

ASSEMBLY

Assembly is easiest with the mast down, although assembly can be done with the mast up.

1. Measure the pin-to-pin length (L below) of the forestay with the tumbuckle in its normal state of adjustment. If the mast is up, raise a tape measure on the jib halyard and add an amount approximately equal to the distance from the top end of the tape to the pin at the top of the forestay. Cut the top end of the luff so that the total luff length is 26" less than the pin-to-pin length. The luff extrusion can be cut with a hacksaw. Remember, measure twice, cut once.

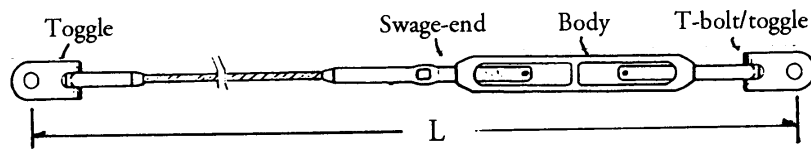

2. The Flexible Furler uses an internal halyard instead of your ship's halyard. Notice that ONE end of the halyard has a traveler (a stainless steel slider) swaged onto it. Push the OTHER end of the halyard up into the cavity in the halyard top fitting and through the off-center hole until the halyard exits over the sheave (see LH photo below). Pull the halyard through the halyard top fitting until the traveler is near the bottom of the halyard top fitting.



Inserting unfinished end of halyard into HTF (bottom view)



Inserting traveler into luff groove



Traveler is opposite sail feed slot (slot is on lower RH side)

3. Insert the traveler into the luff groove opposite the sail feed slot (see middle and RH pictures above). Be sure the halyard slides freely in the groove.

4. Push the halyard top fitting over the top of the luff and secure with the locking screw. Make sure the "OTHER" end of the halyard (the one without the traveler) exits the halyard top fitting over the sheave and on the same side as the sail feed slot (see drawing on page 4).
5. Tie a light line, the length of the luff, to the halyard traveler. This messenger line will be used to raise the sail.
6. If installing with the mast up, tie off and tension a halyard forward to support the mast during the following steps. When the mast is supported, detach the headstay from the chainplate on the bow.
7. Completely unscrew both ends of the turnbuckle.
8. If installing with the mast down, slide the halyard top fitting and luff assembly over the swage end of the turnbuckle and headstay. Pass the headstay through the entire length of luff extrusion until the swage end exits at the other end of the luff.

If installing with the mast up, pass a light line through the entire length of the luff extrusion. At the halyard top fitting end of the assembly, make the light line fast to the swage end using a piece of wire to make the line.



Connecting swage stud to messenger line

9. Pull the headstay through the luff extrusion while pushing the luff extrusion up the headstay. Having a second person on the deck pushing the luff up will greatly facilitate this maneuver (see photo next page).



pushing luff extrusion up forestay



screwing TB on stud

10. When the swage end appears at the bottom end of the luff extrusion, grip the swage end with a pair of vice grips (see RH picture above) to keep the luff extrusion from sliding back down. Then screw the tumbuckle body onto the swage end a couple turns.

11. If you are installing an FF7.0 over a 7/16" T-bolt, or an FF9.0 over a 1/2" T-bolt, slide the adapter (short plastic tube in the loose parts bag) over the T-bolt threads. It will rest between the T-bolt and the center hole in the bearing.

12. Place the antirotation strap between the sides of the toggle. Put up to 4 washers over the T-Bolt to reduce the clearance between the T-Bolt and the bottom of the cup.



Adding washers to T-bolt

13. Select the appropriate pair of holes on the bottom of the cup based on the orientation of the chainplate and furling line (see page 13 for more information). Then screw the antirotation strap, bearing and cup together.



Assembling cup, bearing and antirotation strap

14. Remove the luff support pin in the throat of the furling drum. Slide the furling drum over the luff with the sail feed slot on the same side as the downhaul block. You can clamp vice grips on the swage end to hold up the luff extrusion and the spool.

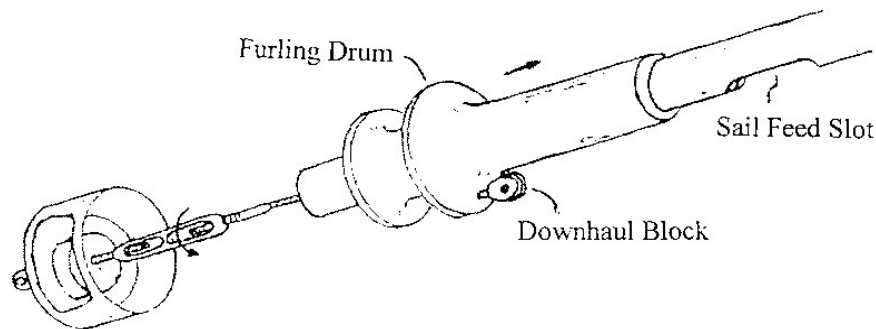

15. If installing with the mast DOWN, screw the T-bolt into the tumbuckle body and adjust until the overall length is correct. Raise the mast and attach the forestay to the chainplate. Adjust the backstay to normal tension. If the forestay length needs to be adjusted, remove the luff support pin and slide the spool up the luff extrusion. You can clamp vice grips onto the swage end to hold the luff extrusion and spool while you are adjusting the tumbuckle.



If installing with the mast UP, first put the cup and bearing assembly in place on the bow and attach the forestay to

the chainplate. Then tension the headstay to its normal state of adjustment. Be sure to **REPLACE THE COTTER PINS IN YOUR TURNBUCKLE**. And remember to **INSTALL THE LUFF SUPPORT PIN** when you lower the furling drum.

16. Pass the furling line through the hole in the side of the cup, then up through the hole in the top of the spool flange. Tie an overhand knot to prevent it from escaping.



Installing the furling line

17. Slide the furling drum down the luff, into the cup and over the main bearing. Lift the luff off the turnbuckle body. Insert the luff support pin through the hole in the furling drum throat. The luff rests on top of this pin (see picture). No hole in the luff is needed for the pin. **CAUTION:** The luff must not sit on the turnbuckle body as turning the furler might unscrew the turnbuckle causing dismasting.



Furler w/ luff support pin installed

18. If your jib is full or almost full hoist, pull the halyard traveler hard up against the halyard top fitting and cut the halyard so that when it is tied to the sail, the head of the sail is just below the sail feed slot. Nicropress an eye for the halyard shackle using the Nicropress double oval sleeve and thimble supplied.

If your sail is not a full hoist sail, estimate the distance from the head of the sail to the mast when the sail is raised (see drawing next page). Call this estimated distance "dimension A." With the halyard traveler hard up against

the halyard top fitting, cut the halyard so that the head to the sail is below the sail feed slot by an amount approximately equal to "dimension A." This may take some experimentation so cut the halyard only after you confirm the length.

Note: When the sail is UP, the traveler is DOWN near the spool.

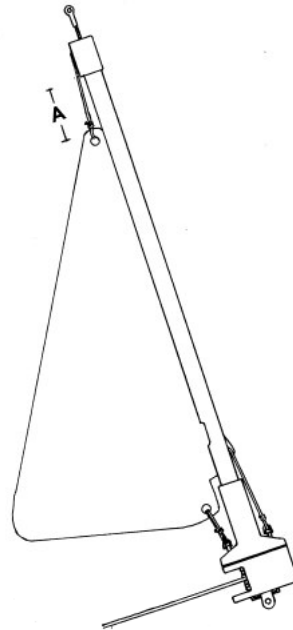

INSTALLING THE FURLING LINE (*Please Read Carefully*)

1. Pass the furling line through the opening in the side of the cup, then up through the hole in the top of the furling drum flange. Tie an overhand knot to prevent it from escaping. Before raising the jib, rotate the furler so there are about 20 turns of furling line on the furling drum.
2. Position the first fairlead or block so that the furling line exits the cup at right angles to the forestay and approximately in the middle of the cup athwartships. Failure to properly position this first lead can result in chafing and cutting of the furling line. In most cases, the first fairlead must be mounted on the deck. Properly bed the screws. If using a sunscreen on your sail, the furling line should be wrapped so the sunscreen is on the outside of the sail when the sail is furled. (The furler can work rotating in either direction.)

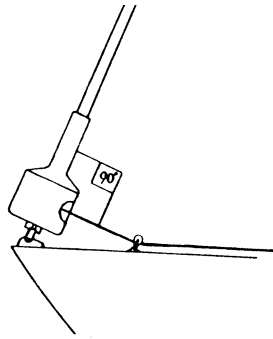

Locating the first Fairlead

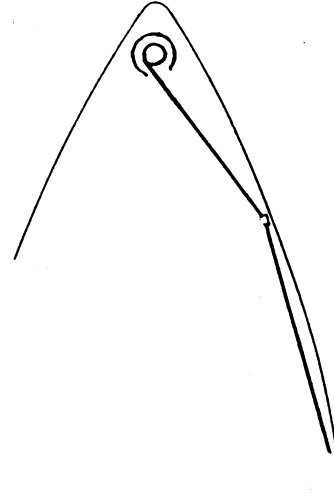

Possible deck layout if UV is on starboard side

3. If you wish to position the first lead at the rail, you may have to turn the cup 45 degrees to the centerline. This may be done by selecting a different pair of holes when installing the antirotation strap.
4. Place a cleat near the cockpit.
Place the cleat in a convenient place out of the way of other sail handling equipment. When furled, you will have a lot of line that needs to be kept clear of other gear.
5. The system is designed for 1/4" dacron line. Make sure you have enough to completely furl your largest sail plus about five extra turns. This will allow you to furl an extra tight furl in heavy winds and still have a couple of turns left. Before hoisting the sail for the first time, wind about twenty turns on the spool. Turns can be added or subtracted as necessary after setting the sail. Here's how to determine the amount of line you need: $(2 \times \text{boat length}) + 10\%$.

HOISTING THE JIB

1. Attach the halyard to head of the jib.

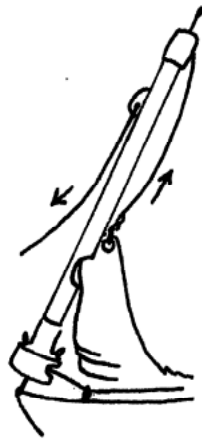

Pull halyard down to hoist sail

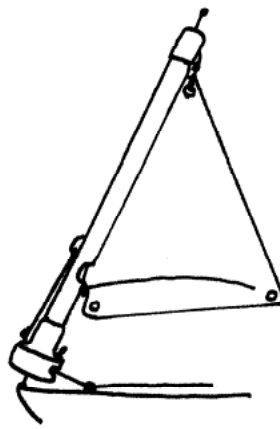

Tie halyard to halyard shackle

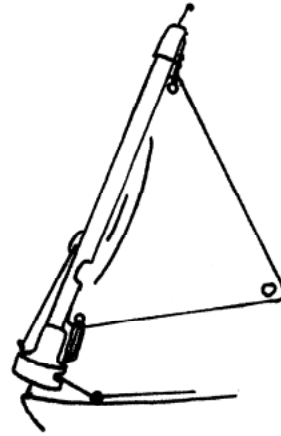

Tension at the bottom of the sail using tack tension line. Lace it 3 or 4 times.

2. Pull up the sail by pulling down on the messenger line attached to the halyard traveler while feeding the luff tape into the sail feed slot. If raising and lowering the sail frequently, a pre-feeder should be added.
3. When the sail is fully hoisted, remove the messenger line and make the end of the halyard tension line fast to the cleat (the short tail of line spliced onto the traveler).
4. Tension the luff of the sail with the 1/8" tack tension line, passing two or three parts through the downhaul shackle on furling drum flange and grommet on sail, and finish off with some half hitches.
5. Add or eliminate furling line on drum as necessary. When sail is furled tightly, there should be 5 to 10 turns left on the furling drum.

LOWERING THE JIB

1. Uncleat the halyard tension line. Tie a messenger line to the halyard tension line.
2. Lower the jib.

SAILING WITH YOUR FURLER

Luff Tension. The jib requires only enough tension to remove the wrinkles along the luff of the sail. This tension will be quite low (perhaps 50 pounds) because modern sails are quite stiff requiring little stretching, and because the luff tape will prevent scalloping often encountered with hank-on sails. This allows the sail to be set up for the entire season without need for adjustment before and after use.

Foam Tape / Shape Tape. Because modern sails are quite stiff, the draft can be controlled with small changes in luff tension. If you are sailing to windward frequently in heavy weather and reef a lot, it may be appropriate to have a foam tape installed on the luff which will help remove the belly in a reefed sail. We suggest you consult your sailmaker.

Furling & Reefing. When sailing reefed, you must move the jib leads forward to maintain the power sheet angle. Failure to do so will lead to poor sail shape and could also cause the furler to rise off the bearing.

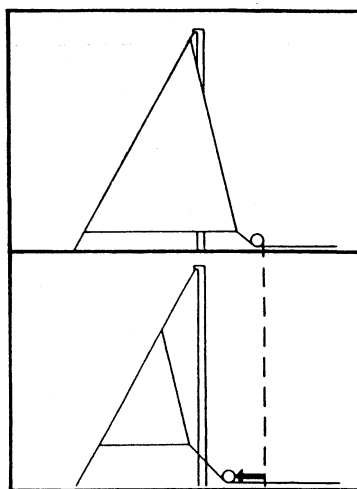

Sheet Lead Change

If after adjusting the lead block forward you still experience the furler lifting up off the bearing, add a piece of PVC tubing over the stay between the halyard top fitting and mast. This will prevent the system from rising up too much. Leave about $\frac{1}{4}$ " play between the halyard top fitting and tubing.

To furl or reef, ease the sheet and pull the furling line until you reach the amount of sail you wish left deployed. Cleat down the furling line. Note: Letting the sheet go all the way may make furling a little easier but will result in an uneven furl.

To unfurl or unreef, ease the furling line while trimming the sheet. *Always keep some tension on the furling line to insure a smooth wrapping of the furling line on the drum.*

In certain conditions, you may wish to use a winch to get the furling started. Be careful that there is no extraneous ship's halyard wrapped in the furler while you winch as this could eventually jam the furler and/or damage the headstay. Always look up at the top of the furler while winching, and stop to clear any snarls. Furling should not get any more difficult as the sail is brought in. It should get easier. If it gets harder, stop and determine why.

Always keep unused halyards flipped aft of the spreaders and lightly tensioned. Do not clip them to the bow.

LAND TRANSPORTING YOUR FLEXIBLE FURLER

Your Flexible Furler is designed to take a lot of abuse. However, if you plan to transport your boat, there are some precautions that will help avoid problems not normally experienced while sailing.

If you leave the furler lashed along the mast while transporting, do not let the furler sag in the middle or at the ends. Pay particular attention to the bottom end as it will probably overlap the bottom of the mast and tend to bounce. To support the drum/cup assembly, lash an extension to the bottom of the mast and tie the bottom of the furler to the extension.

Never lash or store the furler in such a way as to cause a sharp bend. The luff will “remember” the bend. If this inadvertently happens, it is not covered under the warranty, but can be straightened by bending the luff in the opposite sense until it comes straight. Another option is to put the luff in a pipe or tube outside in the sun for one to two weeks during the summer.

MAINTENANCE & STORAGE

The Flexible Furler is a set-it-and-forget-it furling and reefing system. No routine maintenance is required, but an occasional rinsing with fresh water is a good idea. We do not recommend the use of wet lubricants (grease) as such lubricants can trap wear causing dirt particles in the bearing area. Dry lubricants

(teflon sprays, etc) are fine to make furling easier.

When storing for prolonged periods, it is best to strap the furler along the mast, supporting the furler to avoid any potential sagging at the ends as well as in the middle. Do not allow it to drape over the spreaders or any other fitting as the plastic will creep and the luff will kink. Luffs must be stored flat and straight, or warranty is void.

Do not expose the furler to temperatures above 140 degrees F. Such temperatures may frequently occur in warm climates under a boat cover. The higher the temperature, the faster a bend becomes permanent.

To clean the luff, use a rag soaked in paint thinner. For deep scratches and ground in dirt, rub with a rag soaked in acetone. Acetone actually dissolves the luff so even deep scratches can be removed.

BALL BEARING MAINTENANCE

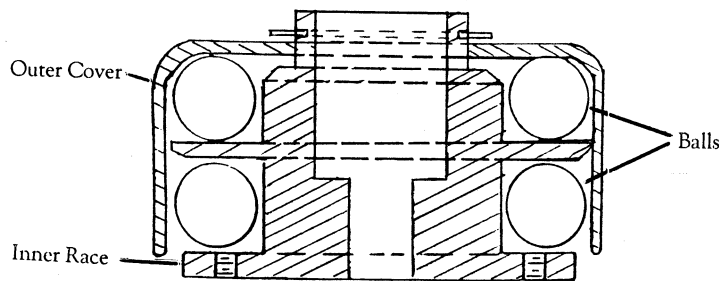

The ball bearing should be rinsed occasionally with fresh water. If the bearing is hard to turn, disassemble for a more thorough cleaning. To do so:

1. Remove the bearing assembly from the headstay;
2. Hold the bearing over a box so that when the balls fall out, which they inevitably will, they won't roll into oblivion.
3. Remove the snap ring at the top of the bearing. Pull the outer race off the inner race.
4. Clean all the balls and both races. Fresh water is normally sufficient, although grease must also be removed if present.
5. Reassemble the bearing by placing 12 of the balls in the outer race (which you turned upside down). Using a small amount of shaving cream or by swirling the outer race, get

all the balls to the outside of the outer race and insert the inner race.

6. Carefully raise and cock the inner race so you can just insert the remaining 12 balls in the unfilled race. When all balls are in place, push down on the inner race. Replace the snap ring.
7. If you used shaving cream during assembly, rinse the bearing in fresh water.
8. Reassemble the bearing, cup and antirotation strap.

SAILMAKER'S INSTRUCTIONS

Luff tape required is #6. Luff deduction is 27" for the FF7.0 and 27" for the FF9.0.

We recommend use of webbing at the head and tack instead of metal grommets. This allows the sail to reef and furl more evenly.

The Flexible Furler cannot be mounted above the turnbuckle as it might put excessive torsional stress on the turnbuckle that could lead to the unscrewing of the turnbuckle and dismasting. To raise the system, shorten the headstay the desired amount and install link plates under the turnbuckle.

The FF7.0 can be used with 1/4" or 7/32" wire with 3/8", 7/16" or 1/2" turnbuckles. THE FF7.0 WILL NOT INSTALL OVER 9/32" WIRE. Check the rigging specifics before ordering.

The FF9.0 can be used with 1/4", 9/32" and 5/16" wire with 1/2" turnbuckles. The FF9.0 fits most 5/8" turnbuckles. Contact CDI for a sample piece of luff extrusion to test the fit of a 5/8" turnbuckle. The Swage stud must be able to pass through the center hole of the extrusion.

The turnbuckle must have a threaded swage-end and T-bolt toggle. Stays with other fittings (eyes, jaws, etc.) must be altered as the antirotation strap will not fit using these other fittings. *You must replace closed body, locknut turnbuckles with open body, cotter pinned turnbuckles.* Lock nuts are not a satisfactory way to lock turnbuckles. Any improper installation could lead to an unscrewing torque on the turnbuckle lock nuts, allowing the turnbuckle to unscrew and the mast to fall

down. This can lead to injury or death.

Toggles are required at the top of the headstay as well as the bottom.

LIMITED 6-YEAR WARRANTY

The Flexible Furler is warranted to remain functional for 6 years from date of purchase. You must be the original purchaser of the unit. If, during this period, any part becomes non-functional, CDI will repair or replace it, free of charge, except for the freight.

This warranty covers:

At Sea: All hazards at sea, including winching against obstructions, unseamanlike use, and dismastings.

Other: This warranty remains in force for charter and other commercial operations. No maintenance is required to keep the warranty in force.

The Flexible Furler warranty does not cover:

At Sea: Shipwreck, collision and acts of God. The warranty is void if the mast is not fixed in place vertically at all times while the boat is in the water. Tipping the mast forward to pass under bridges, power lines or other low clearance obstructions voids the warranty.

On Trailers: Collision; being dragged on the ground; improper stowage resulting in kinks, bends and twists; and damage due to the luff not being supported over its entire length. (See trailering instructions.)

Storage: Any damage caused by improper storage or handling when not at sea. Luffs must be stored flat and straight, or warranty is void. Kinks, twists, bends and breakage due the luff not being stored flat and straight are not covered. Coiling or twisting the luff either to remove kinks and bends, or for transport and storage in other than in a flat and straight condition voids the warranty.